



Specialist Healthcare Seating Range



Support | when you need it the most.

Support | for your client.

Primacare have a broad range of innovative products for your client, to provide comfort and support over a long period of time if necessary.

With such an extensive range of products there must be a suitable chair because we start with simple porter chairs and ultimately offer chairs for users with the most complex needs.



Support | for you the professional

A range of practical support to help you understand, specify and introduce our products.

Whether you are a Specialist Seating assessor, an Occupational Therapist, a Tissue Viability expert or an interested carer, this brochure is a starting point to explain the functions and sizes of the chairs available. In addition the extensive range of seating solutions including pressure management and the large number of accessories and options will allow you to fully specify the correct chair.



primacare | always there

Support when you need it the most



Specialist Healthcare Seating Range

Primacare are excited to show you our latest range of Specialist Seating products.

We have now produced over 100,000 chairs and this experience is evident in the quality of manufacturing and the flexibility and functionality of the designs shown.

Our primary aim is to balance the challenges of comfort and pressure management with posture control and individual independence and the result is this new range of chairs, from the relatively simple design up to the most complex needs.

Contents

Pressure Management	2-3
Alpha	4-5
Alpha Plus	6-7
Affinity Air Comfort	8-9
Monza Assist Riser Porter	10-11
Ultra Low	12-13
Snowdon BLTR	14-15
Affinity Bariatric Porter	16-17
Penarth Chair Bed	18-19
Low Broadway	20-21
Broadway	22-23
Tintern Riser Porter	24-25
The Porter Range	26-27
Simplicity	28-29
Torino	30-31
Cabaret	32-33
Florence	34-35
Adelphi	36-37
Small Adelphi	38-39
Flo Risa	40-41
Cab Risa	42-43
Harmony/Chepstow	44-45
Monza Infection Control	46-47
Contact Express Chairs	48-49

Pressure management

Many people discuss 'Comfort' and 'Pressure relief' and the subjects are inextricably linked.

If we can increase an individual's surface area contact between themselves and their chair then we spread their weight over a larger area, reducing the pressure on their body parts, including legs, bottom, arms and backs.

It is therefore CRITICAL to use a chair that has been measured and adjusted to the

size and shape of the individual. Correct Posture leads to maximising the contact area which in turn minimises pressure on the body parts.

Occupational Therapists and Specialists will advise repositioning every 2 hours and the use of significant tilt angles (up to 45 degrees) which can achieve pressure

reductions particularly in the pelvic area. However the highest pressure is found in the seating cushion area under the bottom and Primacare have 7 different seating arrangements to offer depending on the level of risk of pressure sores and ulcers.

2

Pressure management *mapping*

Primacare different seat cushion options have all been extensively tested using a pressure mat which contains 120 different pressure sensors over the seating area of a chair. Pressure Mapping is unique to the individual user, the type

of cushion and the relative position of the chair. However the mapping can give relative performance and a pressure map when comparing different cushions with the same user.

Please note that users with pressure relief concerns should seek the advice of an Occupational Therapist or Tissue Viability Specialist who can advise on the level of Pressure Relief required.

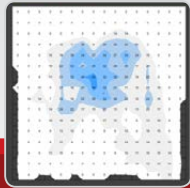

Female 9 stone Age 52
Coolgel Cushion



Male 15 stone Age 50
Primagel Cushion

Pressure management *seat options*

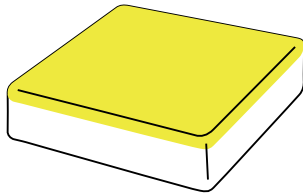

Visco
Medium Risk

The Visco elastic heat sensitive layer is supported by high density Reflex foam.

Body heat moulds the visco layer around any high pressure areas and the result is a stable cushion giving good postural support.

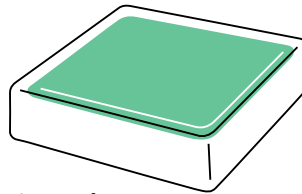

Primagel
High Risk

The cushion uses combustion modified high resilient foam with a profiled upper surface to increase pressure distribution, encasing a silicon gel sac, which dissipates pressure in high areas of loading.

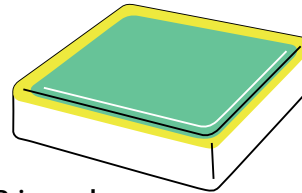

Primagel+
High Risk

The Primagel+ cushion uses the Primagel cushion with an added layer of visco elastic heat sensitive foam.

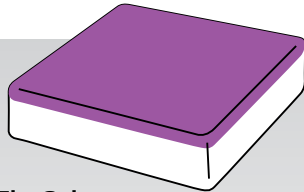

FlatGel
High Risk

The FlatGel cushion uses a Proprietary Silicon Polymer sheet over a high density reflex foam. The Gel has the same physical characteristics as human fat tissue and the softness stays unchanged at any temperature. The polymer is a solid which will not leak if punctured. It is Hypoallergenic – it does not contain latex or isocyanates and it is odourless.

Because of its stability with temperature changes this cushion offers excellent constant postural support over many hours.

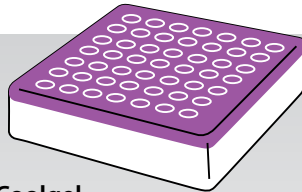

Coolgel
High / Very High Risk

The Coolgel cushion uses a Proprietary Silicon Polymer sheet over a high density reflex foam. The Gel has the same physical characteristics as human fat tissue and the softness stays unchanged at any temperature. The polymer is a solid which will not leak if punctured. It is Hypoallergenic – it does not contain latex or isocyanates and it is odourless. The Coolgel has circular discs of polymer which allows air to circulate between the cells to minimise heat and moisture build up. An even pressure distribution contours to the underlying surface so this cushion can be used all day and still retain its stability.

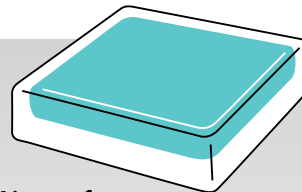

Air comfort
High / Very High Risk

The air comfort cushion uses a combination of longer broad rubber webbing springs with a high density reflex foam seat cushion. This cushion surround an air cell which allows different air pressures and air volumes. This cushion easily contours around the higher protruding parts of the posterior to give an excellent even pressure distribution.

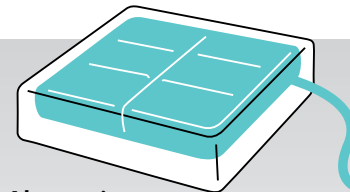

Alternating Air Cushion
High / Very High Risk

The alternating air cushion uses an air pump to continuously inflate and deflate 6 dynamic air cells controlled on a 9minute 36second cycle.

At any one time 4 of the cells are inflated bringing pressure relief to the other areas. A 240V electrical supply is required for the pump which is usually positioned next to the chair.

Alpha | specification.



Alpha chair with optional lateral back cushion.

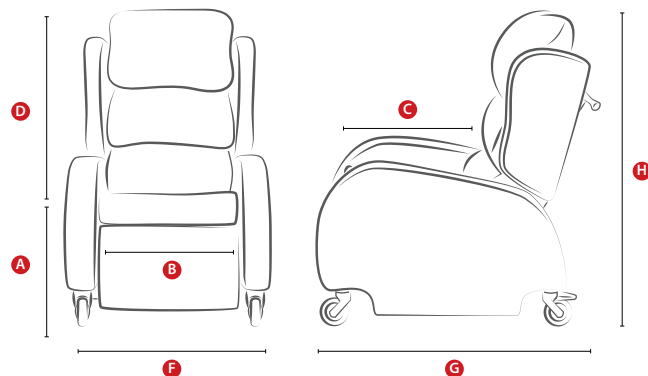

	16W	18W	20W
A seat height	16"	18"	20"
B seat width	16"	18"	20"
C seat depth	18-22"		
D back height	30"		
E back angle	100-130°		
F overall width	25"	27"	29"
G overall depth	35"		
H overall height	43-45"		
weight capacity	25 stone		

Standard features

- Removable double seat cushion
- Manually adjusted seat angle with 4 positions (max 28°)
- Seat depth adjustable
- Pull out footplate
- 4 x swivel 4" diameter castors (2 x rear lockable)
- Ultima vinyl outer - Crib 5
- VP 4 way stretch fabric on seat and back cushions

4

Alpha | features and options.



Two section seat cushion, a 4" thick and 2" thick which allow the chair to have 2 different seat heights. The chair can also be specified with any of the Pressure reducing cushion options



The seat rake angle can be adjusted with quick release plunger pins to give seat angles up to 28 degrees rake



The chair comes as standard with 4" of seat depth movement, easily adjusted by 2 knobs on the underside of the seat



The pull out footplate gives a comfortable position to rest the feet when using as a Porter chair

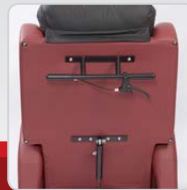

The Back Angle Recline is operated by a handle which has a safety catch on the lever to help avoid accidental use of the recline function. The sturdy push handle can be positioned at 2 heights



An optional footstool is available to create a comfortable relaxed seating position

Alpha

The Alpha chair is an inexpensive solution to Portering needs but with many adjustable features to make this a comfortable all day chair.

The chair has adjustable seat depth, seat rake angle and back rest recline. The chair comes in 2 widths (18" and 20") with a double seat cushion as standard, allowing simple seat height adjustment.

The cushion materials are 4 way stretch vapour permeable fabric which is washable up to 95°C. The use of VP fabric enables the chair to be optionally upgraded with different pressure relieving cushions.



primacare | always there

Alpha Plus | specification.



Alpha chair with optional lateral back cushion.

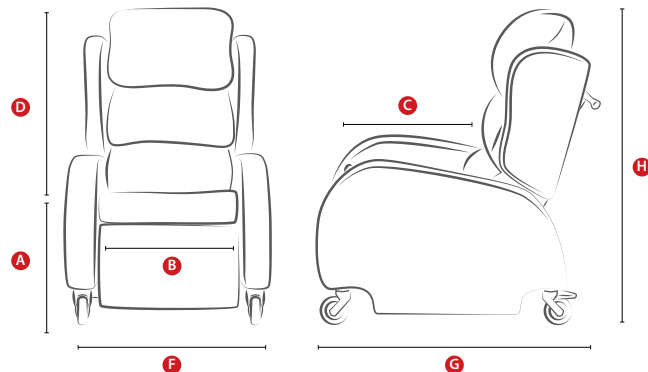

	16W	18W	20W
A seat height	16 - 20"	16 - 20"	16 - 20"
B seat width	16"	18"	20"
C seat depth	18-22"		
D back height	30"		
E back angle	100-130°		
F overall width	25"	27"	29"
G overall depth	35"		
H overall height	43-45"		
weight capacity	25 stone		

Standard features

- Removable seat cushion
- Manually adjustable seat angle up to 30 degree rake
- Seat depth adjustable
- Pull out footplate
- 4 x swivel 4" diameter castors (2 x rear lockable)
- Ultima vinyl outer - Crib 5
- VP 4 way stretch fabric on seat and back cushions

6

Alpha Plus | features and options.



Adjustable back cushions



The chair comes as standard with 4" of seat depth movement, easily adjusted by 2 knobs on the underside of the seat



The pull out footplate gives a comfortable position to rest the feet when using as a Porter chair

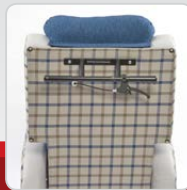

The Back Angle Recline is operated by a handle which has a safety catch on the lever to help avoid accidental use of the recline function. The sturdy push handle can be positioned at 2 heights



An optional footstool is available to create a comfortable relaxed seating position

Alpha Plus

The Alpha Plus is a supportive chair that reclines from a pivot point behind the knee.

This reclining seat is controlled by a smooth powerful gas spring which allows infinite positioning and a steep seat rake if necessary. It promotes a sense of security and relaxation.

The chair has adjustable seat depth and comes in 3 different widths. The chair seat cushion comes with visco pressure relieving foam as standard.

The cushion materials are 4 way stretch vapour permeable fabric which is washable up to 95°C. The use of VP fabrics enables the chair to be optionally upgraded with different pressure relieving cushions.



primacare | always there

Affinity Air Comfort | specification.

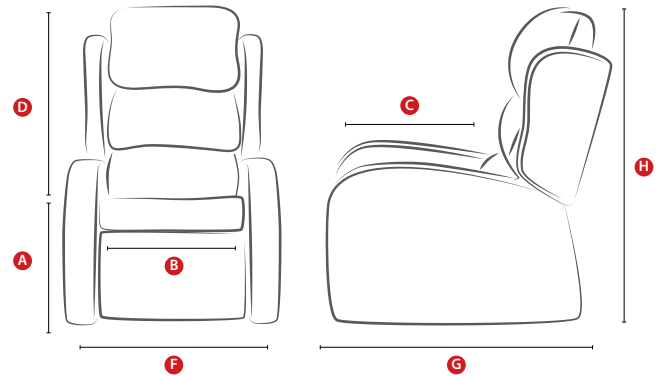

	Petite	Compact	Standard
A seat height	16"	18"	19"
B seat width	18"	18"	20"
C seat depth	18"	18"	20"
D back height	27"	27"	30"
E tilt / back angle	Single 25° / Dual 25° + extra 35°		
F overall width	27"	27"	29"
G overall depth	35"	35"	35"
H overall height	39"	41"	44"
weight capacity	20 stone		

Standard features

- Available with Single or Dual Tilt in Space rise and recline actions
- Ultimate vinyl outer Crib 5 with vapour permeable 4 way stretch fabric on all contact surfaces
- Extra long springs for added comfort
- Air cells in seat and back cushions provide infinite pressure adjustment

8

Affinity Air Comfort | features and options.



The Standard Affinity Air Comfort chair uses Single or Dual Tilt in Space Riser actions with a 20 stone weight capacity. Bespoke sizes and actions with Variable Angle Lift (VAL) are available at extra cost



The Affinity chair comes as standard with a removable seat system and a removable back cushioning. This allows for easy access to the air cells



The Affinity chair shown has the high leg lift Tilt in Space actions but it can be specified with a conventional dual action which gives individual control of the legrest and back rest but with no tilt



The 3 air cells are easily adjusted using the Hand held inflation bulb

Affinity

Air Comfort

The Affinity Air Comfort chair has been designed with maximum comfort in mind.

To achieve this there is a special seat construction with extra long springs to give more bounce. The seat and back cushions are made up with 3 individually controlled air cells to allow the occupant to personalise the comfort. The chair contact surfaces use 4 way stretch vapour permeable fabric which adds to the comfort of the chair.

This combination of long springs, soft foam, air cells and stretch fabric have been proved with pressure mapping to classify this seating as high risk.



primacare | always there

Monza Assist Riser Porter | specification.

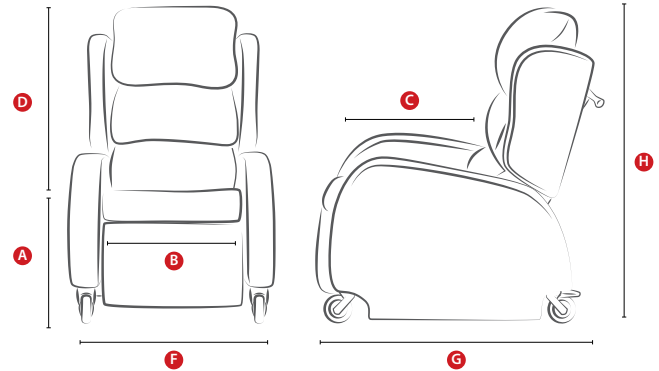

	Petite	Compact	Standard
A seat height	16"	18"	19"
B seat width	18"	18"	20"
C seat depth	18"	18"	20"
D back height	27"	27"	30"
E tilt / back angle	Single 25° / Dual 25° + extra 35°		
F overall width	27"	27"	29"
G overall depth	35"	35"	35"
H overall height	39"	41"	44"
weight capacity	15 stone	20 stone	20 stone

Standard features

- Choice of Single or Dual Tilt in Space Rise and Recline actions
- Ultima vinyl Crib 5 with waterproof vapour permeable 4 way stretch fabric on all contact surfaces
- 3" diameter braked castors on all 4 wheels

10

Monza Assist Riser Porter | features and options.



The arm design allows the user to get close to the chair and with it partially raised if necessary



High rise 'Get out' position



Comfortable Tilt in Space recline with high leg lift



Magnetic handset attachment



Compact lockable castors on all 4 wheels

Monza Assist

Riser Porter

The Monza Assist Riser Porter Chair combines the functionality of a comfortable Rise and Recline chair with the added mobility of a wheeled porter chair. The modern Monza style chair is narrow at the lower arm allowing the use of an Able Assist or Sara Steddy to get users close to the chair.



primacare | always there

Ultra Low | specification.

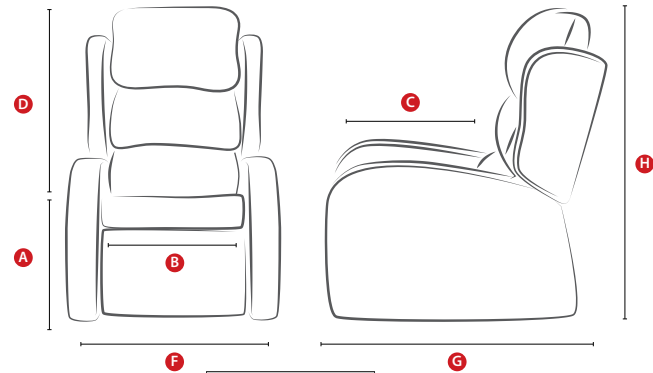

		Standard
A	seat height	10 - 16"
B	seat width	10 - 34"
C	seat depth	12 - 24"
D	back height	12 - 30"
E	tilt / back angle	Single 25° / Dual 25° + extra 35°
F	overall width	Seat width plus 12"
G	overall depth	35"
H	overall height	39"
	weight capacity	20 stone

Standard features

- Choice of Single or Dual Tilt in Space Rise and Recline actions
- Ultima vinyl Crib 5 with waterproof vapour permeable 4 way stretch fabric on all contact surfaces
- 4" diameter swivel castors with the 2 rear braked
- Drop down footplate

12

Ultra Low | movement.



Chair in normal seating position



Chair raised showing flat lift



Chair in rise position



Chair in tilt recline position

Ultra Low

The Ultra Low chair is designed for people of short stature who need comfortable tilt in space recline and a rising chair for help when standing.

The chair has seat heights from 10" upwards but with normal thickness's of cushioning making this a very comfortable chair, with weight capacities up to 20 stone.

The mechanisms are hidden in the arms of the chair to allow for the comfortable seating and pressure relieving options if necessary.



primacare | always there

Snowdon *Bariatric* | specification.



Snowdon Bariatric chair with 2 optional drop arms and electric seat retraction

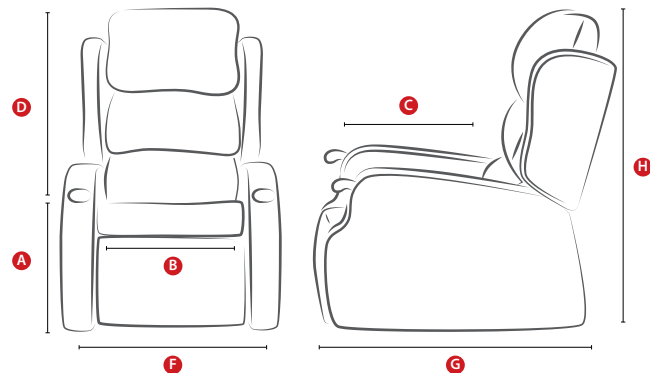

		Standard			
A	seat height	16-22"			
B	seat width	18-36"			
C	seat depth	18-26"			
D	back height	27-33"			
E	back angle	40° plus 30° tilt			
F	overall width	Seat plus 9"			
G	overall depth	38"			
H	overall height	Seat height plus back height minus 3"			
	weight capacity	25	35	40	50
	leg rest weight	13	20	22	25

Standard features

- BLTR action with separate control of Back, Leg, Tilt and Rise functions
- Ultima vinyl Crib 5 with waterproof vapour permeable 4 way stretch fabric on all contact surfaces
- Removable seat quilt system giving access to the seat foam block
- 25 stone extra heavy duty leg rest
- Flat vertical lift if required

14

Snowdon *Bariatric* | features and options.



Seat retracted



Seat extended



Drop arm lowered



Optional electrically extending legrest

Optional electrically operated seat retraction which gives 6" seat depth adjustment

The Bariatric chair shown on this page is the Snowdon style chair. It is possible to make any style of chair using the Bariatric 40 and 50 stone BLTR actions

Snowdon BLTR

Bariatric

The Snowdon Bariatric Chair has a choice of weight capacities - 25, 35, 40 and 50 stone, and uses the strong and reliable BLTR actions.

This gives the user separate control of the Back angle, Leg rest, Tilt and Rise functions of the porter chair.

The chair is designed with a low construction height which allows for thick seat cushioning for extra comfort and longevity.

The removable seat system allows the provision of all of the pressure management solutions shown on page 3.



primacare | always there

Affinity Bariatric Porter | specification.

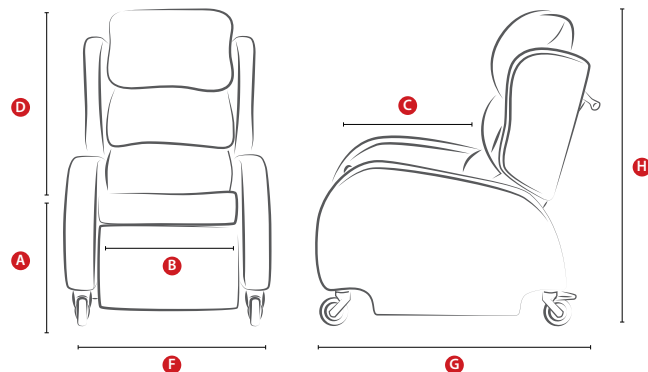

		Standard
A	seat height	16-22"
B	seat width	24-34"
C	seat depth	18-26"
D	back height	27-33"
E	back angle	40° plus 30° tilt
F	overall width	Seat plus 9"
G	overall depth	38"
H	overall height	Seat height plus back height minus 3"

Standard features

- BLTR action with separate control of Back, Leg, Tilt and Rise functions
- Ultima vinyl Crib 5 with waterproof vapour permeable 4 way stretch fabric on all contact surfaces
- Removable seat quilt system giving access to the seat foam block
- 4" diameter swivel castors with braked rear castors
- 25 stone extra heavy duty leg rest
- Flat vertical lift if required

Affinity Bariatric Porter | features and options.



The Bariatric Porter can be reclined and tilted to create an almost bed like flat position



This is a heavy chair and one carer will only move the chair small distances with the user seated



The Porter chair has a good high get out position



The chair can be raised 4" vertically

The Bariatric Porter shown on this page is the Affinity style chair. It is possible to make any style of chair using the BLTR Porter action but consideration should be given to the width of the arm assuming the Porter chair will have to go through doors

Affinity

Bariatric Porter

The Affinity Bariatric Porter has a weight capacity of 40 or 50 stone and uses the reliable BLTR actions.

This gives the user separate control of the Back angle, Leg rest, Tilt and Rise functions of the porter chair.

With chairs of this weight capacity the portering aspect is to allow the chair to be moved around without the user in the chair. It would be very difficult for 2 carers to move the chair with a 50 stone occupant.



primacare | always there

Penarth Chair Bed | specification.

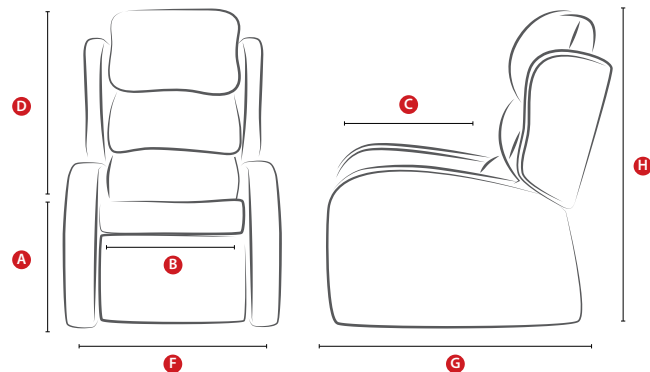

		Standard
A	seat height	16-22"
B	seat width	18-34"
C	seat depth	18-22"
D	back height	27-33"
E	back angle	50°
F	overall width	Seat width plus 9"
G	overall depth	38"
H	overall height	Seat height plus back height minus 3"

Standard features

- BLTR action with separate control of Back, Leg, Tilt and Rise functions
- Flat vertical lift if required
- 2 drop arms manually operated (optional electric drop arms)

18

Penarth Chair Bed | features and options.



Sleeping position



Sitting feet up



Get out rise position



Flat lift position



Trendelenburg position

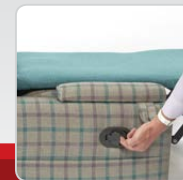

Drop arm operational lever

Penarth

Chair Bed

The Penarth Chair Bed is a chair that converts to a bed. With the addition of Drop Arms and the infinite positioning of separate Back, Leg, Tilt and Rise motors it is always possible to create a comfortable sitting and sleeping position.



primacare | always there

Low Broadway Care Chair | specification.

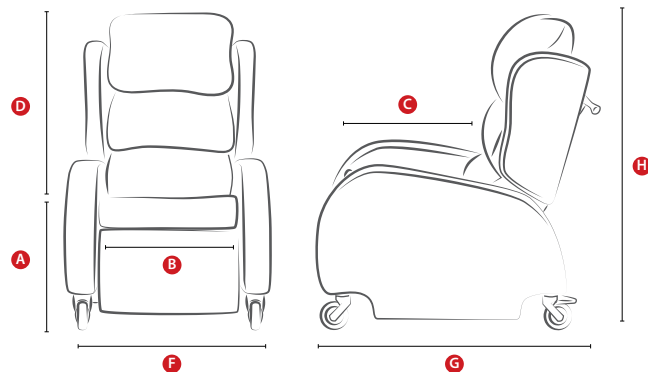

20

Low Broadway Care Chair features and options.

	Small	Medium	Large	X Large
A seat height to footplate	13" - 18"			
seat height to floor	20"	20"	20"	20"
B seat width	16"	18"	20"	22"
C seat depth	18"	18"	20"	20"
D back height	27"	27"	30"	30"
E back angle	35°			
tilt in space	35°			
F overall width	25"	27"	29"	31"
G overall depth	38°			
H overall height	44"	44"	47"	47"
weight capacity	25 stone			

Standard features

- 3 waterfall back as standard
- Visco foam topper on seat cushion supplied with standard specification
- Ultima vinyl Crib 5 outer fabric with waterproof vapour permeable 4 way stretch fabric on all contact surfaces
- Removable seat system to allow the use of alternative pressure relieving seat cushioning
- Footplate Included
- 4 large castors, rear are braked



Optional butterfly back



Optional double height soft lateral back



Removable, height and angle adjustable footplate comes as standard

Low Broadway

Care Chair

The Low Broadway Care Chair is available in both manual and electric control options. It is compatible with all the pressure management options shown on page 3.

The chair is available in 4 width options and uses a height and angle adjusted flip up footplate which is detachable.

*Low Broadway 18" seat width in Etch Hyacinth Vinyl with Navy VP cushioning. This photograph show the Optional Double Height Lateral Back Cushion.



primacare | always there

Broadway Care Chair | specification.

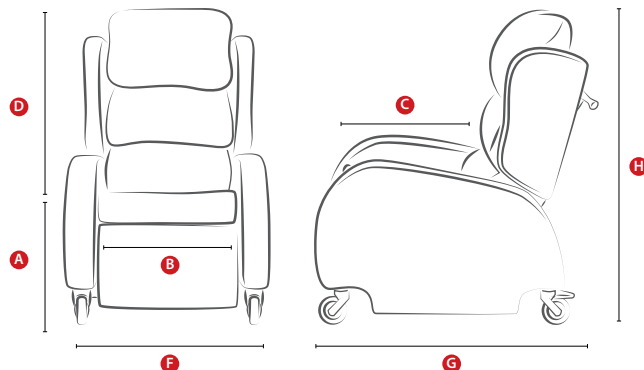

	Small	Medium	Large	X Large
A	seat height to footplate 16 - 21"			
B	16"	18"	20"	22"
C	18"	18"	20"	20"
D	27"	27"	30"	30"
E	back angle 35°			
	tilt in space 35°			
F	25"	27"	29"	31"
G	overall depth 38"			
H	44"	44"	47"	47"
	weight capacity 25 stone			

Standard features

- 3 waterfall back as standard
- Visco foam topper on seat cushion supplied with standard specification
- Ultima vinyl Crib 5 outer fabric with waterproof vapour permeable 4 way stretch fabric on all contact surfaces
- Removable seat system to allow the use of alternative pressure relieving seat cushioning
- Footplate Included
- 4 large castors, rear are braked

22

Broadway Care Chair features and options.



Optional air comfort system with air cells in seat and back



Fixed angle footplate is a standard feature on all Broadway Care Chairs



Optional butterfly back



Optional double height soft lateral back

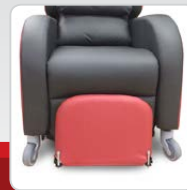

Optional flip up footplate

Broadway

Care Chair

The Broadway Care Chair is available in both manual and electric control options. It is compatible with all the pressure management options shown on page 3.

This is a hoist friendly chair and will most regularly be used by hoisted occupants. The chair is available in 4 sizes and uses a manually adjusted separate footplate to support the feet.



primacare | always there

Tintern Riser Porter Chair | specification.

		Standard
A	seat height	17-22"
B	seat width	16-24"
C	seat depth	16-22"
D	back height	27-33"
	weight capacity	20 stone

Flexible positioning.

Please note: The chair has a 25 stone weight capacity but most carers will struggle to manoeuvre clients over 15 stone in weight.



Tintern Riser Porter Chair | features and options.



High rise position



Full recline position



High leg lift position



4 large swivel castors, 2 at rear are lockable



Optional profile head cushion

Tintern

Riser Porter Chair

A mobile rise and recline chair with optional single or dual tilt in space control.

- Optional Single or Dual Tilt in Space actions.
- Optional full battery back up with freedom pack, no wires and up to 80 cycles.
- Various foam/gel seating options including high risk pressure relief.
- Any fabric.
- Easy clean infection control option with magnetic cushions.



primacare | always there



Foot tray extended



Seat can be extended forwards



TV position



Relaxed sleeping position

Push back manual

1. Easy to use manual recliner Porter chair.
2. Extra long extending legrest.
3. Removable seat module including Visco seat foam topper as standard.
4. Push handle for Carer to push chair or pull back to recline chair.
5. Sliding foot tray.
6. 4 swivel castors, 2 at rear braked.



Can be adjusted to a very upright position

Reclined



Tilted back

Extra back angle recline

Dual Tilt in Space

Electric & Manual versions

1. Smooth electric Tilt in Space recline action, or manual legrest operated by finger pull handle and handle with trigger for Tilt in Space recline.
2. The dual tilts in space in an identical manner to the single motor chairs. The extra motor allows adjustable back angle positioning.
3. Sliding foot tray.
4. Removable cushioning for seat depth alteration. Continuous leg support quilt with Visco foam as standard.
5. 4 swivel castors, 2 at rear braked.



The Porter Range



Single Tilt in Space

Electric & Manual versions

1. Smooth electric Tilt in Space recline action, or manual legrest operated by finger pull handle and handle with trigger for Tilt in Space recline.
2. Sliding foot tray.
3. Removable cushioning for seat depth alteration. Continuous leg support quilt with Visco foam as standard.
4. 4 swivel castors, 2 at rear braked.



Foot tray extended.



Lateral support cushions (optional extra)



Normal recline.



High leg recline.



Fully removable seat and quilt.



Different seat cushion modules available

Primacare can make porter chairs to whatever size and action type are required.

The chair shown here is a 40 stone heavy leg lift (20 stone) porter chair with a seat width of 30". The chair and wheels are designed to support occupants but this would be in a static situation.

The mobile aspect of this chair is to move the chair without the service user in the chair. 2 nurses would not be able to push an occupant with a weight of 40 stone successfully. An optional electrically powered 5th wheel can be added to assist when portering heavy occupants.

Bariatric BLTR 40 stone

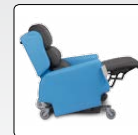

Chair tilted with high extending leg rest



Strong leg rest (20 stone)



Power assisted portering

Simplicity Level 3 care chair | specification.

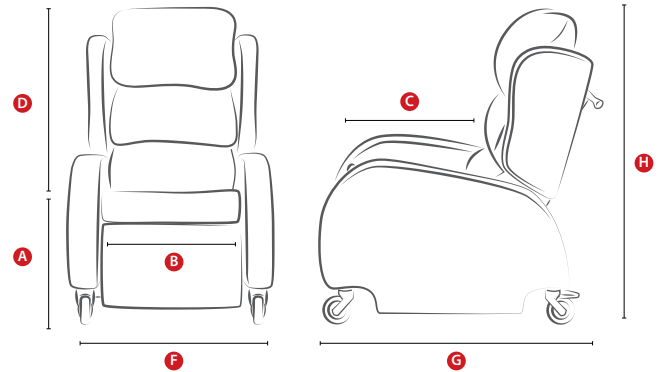

		Standard
A	seat height	19"(14-18 to footplate)
B	seat width	16", 18" or 20"
C	seat depth	17" - 20"
D	back height	30"
E	tilt / back angle	40°
F	overall width	28"
G	overall depth	36"
H	overall height	47"
	weight capacity	25 stone

Standard features

- Manual Tilt in Space
- Manual Legrest Operation
- Removable Seat Cushion with visco topper (medium risk)
- Seat Depth adjustable 17"-20"
- 3 seat width options – 16", 18", 20"
- Comfortable Profile Backrest
- Adjustable angle integral headrest
- Vertically removable arms for easy hoist access or side transfer
- Easily removable top arms for seat width alteration
- Tilt in Space 40 degrees
- Adjustable negative legrest up to 30 degrees
- 4 x swivel 4" diameter castors. 2 x rear lockable
- Ultima Vinyl Outer fabric - Crib 5
- Vapour Permeable 4 way stretch fabric on Seat and Back cushions

28

Simplicity Level 3 care chair | features and options.



Removable, Height adjustable and angle adjustable footplate is optional



Thoracic supports positioned from two possible tubes



Coolgel seat - high risk pressure relief



Easily adjusted legrest angle - negative to positive



Optional Channel legrest with narrower footplate

Simplicity

Level 3 care chair

The Simplicity is a highly mobile seating system providing the adjustability to create correct posture and a supportive comfortable seating position.

The Simplicity chair has a vertically removable arm making this an excellent chair for those who are hoisted or able to side transfer.

The chair has easily removable parts making this an ideal chair for care providers and for reissue to new users.



Simplicity chair 16" seat width with optional thoracic supports and optional footplate



primacare | always there

Torino Level 4 Care Chair | specification.

Standard features

- Independent Tilt in Space
- Adjustable Back Angle
- Adjustable Seat Depth
- Adjustable Seat Width
- Adjustable Arm Height
- Adjustable and removable footplate
- Removable seat cushion
- Ultima vinyl Crib 5 with vapour permeable fabric on all contact surfaces
- Medium risk visco foam on all contact surfaces
- Manual and Electric control options

	Standard
A	seat height to footplate 14-18"
B	seat width 15-19.5"
C	seat depth 16-23"
	arm height 7"
D	back height 30"
E	back angle Recline 30 degrees
	tilt in space 30 degrees
F	overall width 26.5" (minimum)
	weight capacity 20 stone



Tilt in space action

Separate back angle recline from 95° to 135°

Fixed support tube for thoracic supports

Extending individually controlled leg rest

Angle adjustable foot plate that is height adjustable and neatly folds away when not required. With removable cover

Braked rear castors

Swivel castors at front



Push handle with levers for Tilt and Back Angle control. Both levers have safety catches to avoid sudden operation

Torino Level 4 Care Chair | features and options.



Excellent tilt and high leg lift



Seat width and arm angle is easily adjusted with 2 captive knobs



The back of the chair can be operated in 3 positions to give extra seat depth adjustment



The seat cushion can be moved for seat depth adjustment, or replaced with different cushions with pressure management options

The Back Angle Recline of this chair allows for individual adjustment of the spine/pelvic angle



Torino

Level 4 Care Chair

The Torino is a multi positional multi adjustable chair which can accommodate over 90% of the population.

The Torino is available as a fully manual chair operated by levers and gas springs, or each of the functions can be operated electrically with the control by a handset.

As such the chair is suitable for those with complex needs and suitable for home, nursing and residential environments.

The Torino can also be ordered in any technical fabric for the outer but we recommend the use of 4 way stretch fabric on all the cushioning to maintain the integrity of any pressure relief and not to compromise the comfort of the chair.

Additional options provide excellent postural support and pressure management making the Torino a class leading chair.

Torino chair in Cream Ultima with Black VP cushioning. The chair shows the standard removable height and angle adjustable footplate and optional thoracic supports.



primacare | always there

Cabaret Level 4 Care Chair | specification.

Standard features

- Independent Tilt in Space
- Adjustable Back Angle
- Adjustable Upper Back profile
- Adjustable Seat Depth
- Adjustable Seat Width
- Adjustable Arm Height
- Adjustable and removable footplate
- Telescopic extending legrest
- Removable arms for side transfer
- Removable seat cushion
- Ultima vinyl Crib 5 with vapour permeable fabric on all contact surfaces
- Medium risk visco foam on all contact surfaces
- Manual and Electric control options

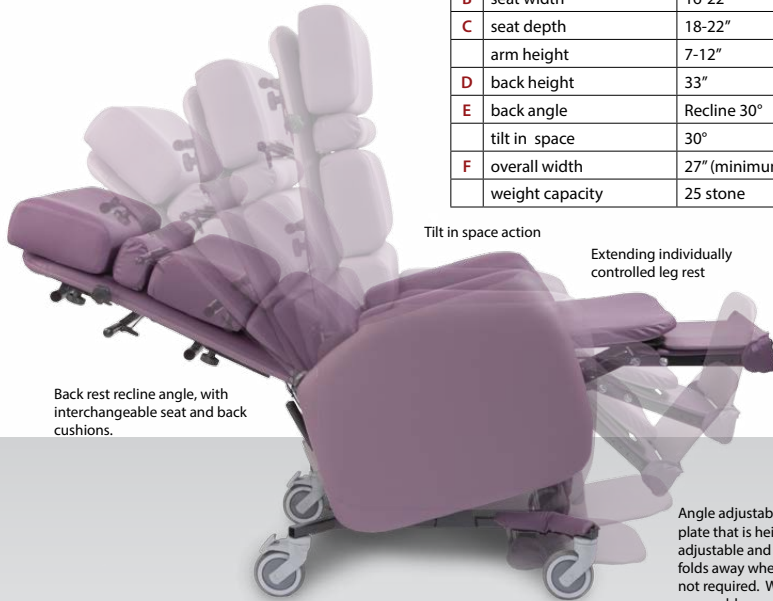

Back rest recline angle, with interchangeable seat and back cushions.

Tilt in space action

Extending individually controlled leg rest

Angle adjustable foot plate that is height adjustable and neatly folds away when not required. With removable cover

Braked rear castors

Swivel castors at front

	Standard
A	seat height to footplate 16-21"
B	seat width 16-22"
C	seat depth 18-22"
	arm height 7-12"
D	back height 33"
E	back angle Recline 30°
	tilt in space 30°
F	overall width 27" (minimum)
	weight capacity 25 stone

Height adjustable support tubes for thoracic supports and wings

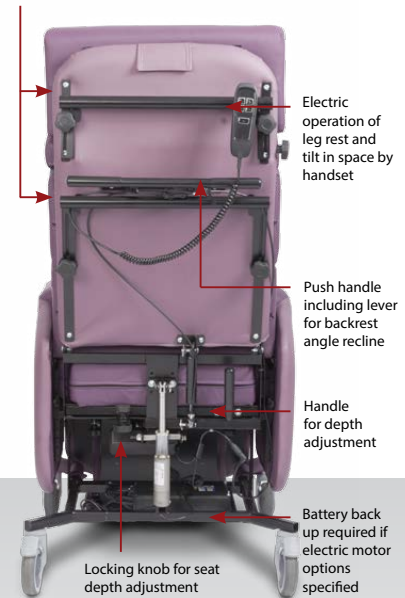

Electric operation of leg rest and tilt in space by handset

Push handle including lever for backrest angle recline

Handle for depth adjustment

Battery back up required if electric motor options specified

Locking knob for seat depth adjustment

Articulating back

Cabaret Level 4 Care Chair | features and options.



Thoracic supports



Profile head cushion



Leg laterals



Leg rest channel cushion



Soft head cushion



Upper adjustable wings



Split thoracics



Depth adjustable thoracics

Ramped seat

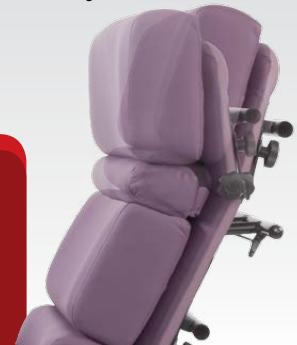

Cabaret

Level 4 Care Chair

The Cabaret chair is a multi positional multi adjustable chair which can accommodate over 90% of the population.

The Cabaret is available as a fully manual chair operated by levers and gas springs, or each of the functions can be operated electrically with the control by a handset.

As such the chair is suitable for those with complex needs and suitable for home , nursing and residential environments.

The Cabaret can also be ordered in any technical fabric for the outer but we recommend the use of 4 way stretch fabric on all the cushioning to maintain the integrity of any pressure relief and not to compromise the comfort of the chair.

Additional options provide excellent postural support and pressure management making the Cabaret a class leading chair.



primacare | always there

Florence Level 4 Care Chair | specification.

Standard features

- Independent Tilt in Space
- Adjustable Back Angle
- Adjustable Upper Back profile
- Adjustable Seat Depth
- Adjustable Seat Width
- Adjustable Arm Height
- Adjustable and removable footplate
- Telescopic extending legrest
- Removable arms for side transfer
- Removable seat cushion
- Ultima vinyl Crib 5 with vapour permeable fabric on all contact surfaces
- Medium risk visco foam on all contact surfaces
- Manual and Electric control options

	Standard
A	seat height to footplate 16-21"
B	seat width 16-22"
C	seat depth 18-22"
	arm height 7-12"
D	back height 33"
E	back angle Recline 30°
	tilt in space 30°
F	overall width 27" (minimum)
	weight capacity 25 stone



Height adjustable support tube for thoracic supports

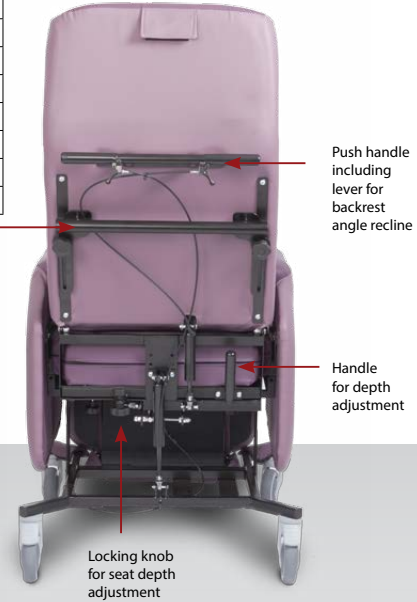

Florence Level 4 Care Chair | features and options.



Thoracic supports



Profile head cushion



Leg laterals



Leg rest channel cushion



Soft head cushion



Upper adjustable wings



Split thoracics



Depth adjustable thoracics

Ramped seat

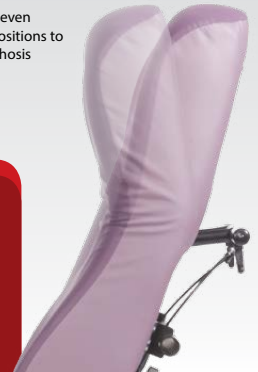

Florence

Level 4 Care Chair

The Florence chair is a multi positional multi adjustable chair which can accommodate over 90% of the population.

The Florence is available as a fully manual chair operated by levers and gas springs, or each of the functions can be operated electrically with the control by a handset.

As such the chair is suitable for those with complex needs and suitable for home , nursing and residential environments.

The Florence can also be ordered in any technical fabric for the outer but we recommend the use of 4 way stretch fabric on all the cushioning to maintain the integrity of any pressure relief and not to compromise the comfort of the chair.

Additional options provide excellent postural support and pressure management making the Florence a class leading chair.



primacare | always there

Adelphi Care Chair | specification.



		Standard
A	seat height to footplate	16-21"
B	seat width	16-22"
C	seat depth	18-22"
	arm height	7-12"
D	back height	33"
E	back angle	Recline 30°
	tilt in space	30°
F	overall width	27" (minimum)
	weight capacity	25 stone

Standard features

- Independent Tilt in Space
- Adjustable Back Angle
- Adjustable Seat Depth
- Adjustable Seat Width
- Adjustable Arm Height
- Adjustable and removable footplate
- Telescopic extending legrest
- Removable arms for side transfer
- Removable seat cushion
- 3 fibre filled waterfall back cushions which are removable and re-positionable
- Ultima vinyl Crib 5 with vapour permeable fabric on all contact surfaces Medium risk visco foam on all contact surfaces Manual and Electric control options

36

Adelphi Care Chair | features and options.

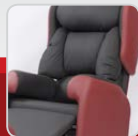

Optional Soft lateral support cushion



The Adelphi has a very high leg position if required and a good Tilt in Space



The arms are removable for seat width adjustment or for ease of side transfer

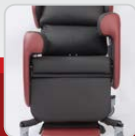

The arm height is easily adjusted at increments of 1"



Leg laterals



Leg rest channel cushion

Ramped seat



primacare | always there

Adelphi

Care Chair

The Adelphi is a sister model of the successful Florence and Cabaret designs and uses the same frame with the same controls.

However the Adelphi back style uses soft cushioning and Conventional wings to give postural support, sometimes with optional extras such as soft lateral support cushions.

The Adelphi is available with manual or electric controls of the 3 main operations; leg rest, tilt and back angle.



Small Adelphi Care Chair | specification.



Adelphi with optional middle lateral support cushion

Small Adelphi

		Standard
A	seat height to footplate	13-18"
B	seat width	12-18"
C	seat depth	14-18"
	arm height	7-12"
D	back height	28"
E	back angle	Recline 30°
	tilt in space	30°
F	overall width	24" (minimum)
	weight capacity	20 stone

Standard features

- Independent Tilt in Space
- Adjustable Back Angle
- Adjustable Seat Depth
- Adjustable Seat Width
- Adjustable Arm Height
- Adjustable and removable footplate
- Telescopic extending legrest
- Removable arms for side transfer
- Removable seat cushion
- 3 fibre filled waterfall back cushions which are removable and re-positionable
- Ultima vinyl Crib 5 with vapour permeable fabric on all contact surfaces Medium risk visco foam on all contact surfaces Manual and Electric control options

38

Small Adelphi Care Chair | features and options.

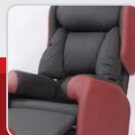

Optional Soft lateral support cushion



The Adelphi has a very high leg position if required and a good Tilt in Space



The arms are removable for seat width adjustment or for ease of side transfer

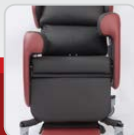

The arm height is easily adjusted at increments of 1"



Leg laterals



Leg rest channel cushion

Ramped seat



primacare | always there

Small Adelphi

Care Chair

The Small Adelphi is a sister model of the successful Florence and Cabaret designs and uses the same frame with the same controls.

However the Small Adelphi back style uses soft cushioning and Conventional wings to give postural support, sometimes with optional extras such as soft lateral support cushions.

The Small Adelphi is available with manual or electric controls of the 3 main operations; leg rest, tilt and back angle.



Flo Risa Rising Care Chair | specification.

Standard features

- Independent Tilt in Space
- Innovative Rise function giving 5" vertical movement
- Adjustable Back Angle
- Adjustable Upper Back profile
- Adjustable Seat Depth
- Adjustable Seat Width
- Adjustable Arm Height
- Adjustable and removable footplate
- Telescopic extending legrest
- Removable arms for side transfer
- Removable seat cushion
- Ultima vinyl Crib 5 with vapour permeable fabric on all contact surfaces
- Medium risk visco foam on all contact surfaces
- Manual and Electric control options

		Standard
A	seat height to floor	16-21"
B	seat width	16-22"
C	seat depth	18-22"
	arm height	7-12"
D	back height	33"
E	back angle	Recline 30°
	tilt in space	30°
F	overall width	27" (minimum)
	weight capacity	20 stone



Height adjustable support tube for thoracic supports

Push handle including lever for backrest angle recline

Handle for depth adjustment

Locking knob for seat depth adjustment

The articulating back can be easily adjusted to give a different profile and accommodate kyphosis



Leg rest channel cushion

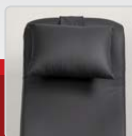

Soft head cushion

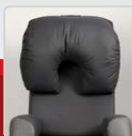

Profile head cushion



Optional Thoracic supports



Leg laterals

Ramped seat



The manual Flo Risa can be easily raised by pumping the foot pedal

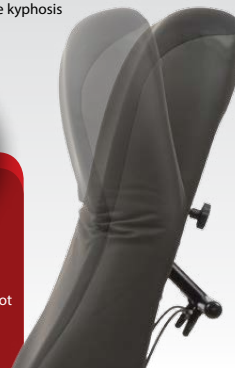

Flo Risa

Rising Care Chair

The Flo Riser is a simple to operate level 3 care chair which is designed to maximise comfort, improve postural support and give a choice of pressure management.

The chair is multi positionable and fully adjustable with separate controls for the Leg rest, Tilt in Space, Back Angle and the Rise function.

The Flo Risa can be supplied with manual controls, electric controls or a mixture of both.



primacare | always there

Cab Risa *Rising Care Chair* | specification.

Standard features

- Independent Tilt in Space
- Innovative Rise function giving 5" vertical movement
- Adjustable Back Angle
- Adjustable Upper Back profile
- Adjustable Seat Depth
- Adjustable Seat Width
- Adjustable Arm Height
- Adjustable and removable footplate
- Telescopic extending legrest
- Removable arms for side transfer
- Removable seat cushion
- Ultima vinyl Crib 5 with vapour permeable fabric on all contact surfaces
- Medium risk visco foam on all contact surfaces
- Manual and Electric control options

		Standard
A	seat height to floor	16-21"
B	seat width	16-22"
C	seat depth	18-22"
	arm height	7-12"
D	back height	33"
E	back angle	Recline 30°
	tilt in space	30°
F	overall width	27" (minimum)
	weight capacity	20 stone

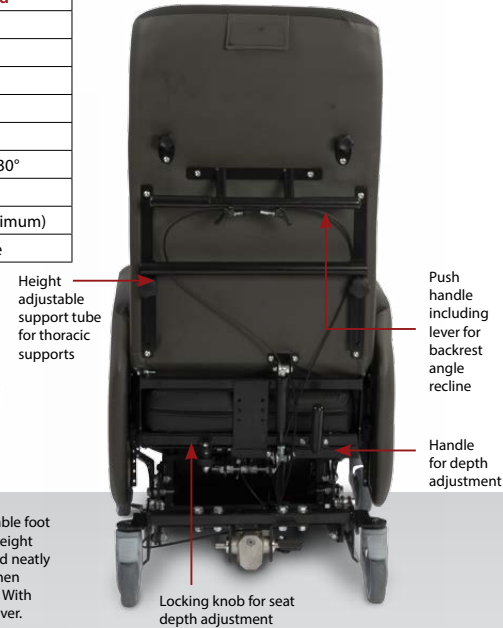

The articulating back can be easily adjusted to give a different profile and accommodate kyphosis

Cab Risa *Rising Care Chair* | features and options.

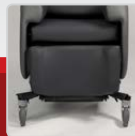

Leg rest channel cushion



Soft head cushion

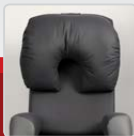

Profile head cushion

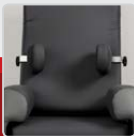

Optional Thoracic supports



Leg laterals



Ramped seat



The manual Cab Risa can be easily raised by pumping the foot pedal

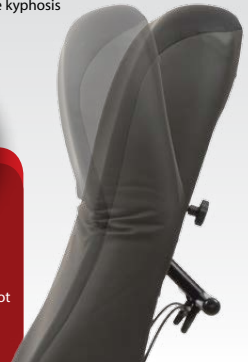

Cab Risa

Rising Care Chair

The Cab Risa is a simple to operate level 3 care chair which is designed to maximise comfort, improve postural support and give a choice of pressure management.

The chair is multi positionable and fully adjustable with separate controls for the Leg rest, Tilt in Space, Back Angle and the Rise function.

The Cab Risa can be supplied with manual controls, electric controls or a mixture of both.



primacare | always there

Harmony

High back

Comfortable High Back chair with removable seat cushion.

The Harmony High Back chair has a separate removable seat cushion to enable the use of all 7 pressure management seating options supplied by Primacare.

Supplied in technical waterproof vinyls and with 4 way stretch fabric on all contact surfaces this can be a very comfortable chair.

The chair is available in 4 sizes and bespoke, there are 2 choices of wood colour.

	Small	Medium	Large	X Large	Bespoke
seat height	16"	18"	20"	20"	14 - 25"
seat width	16"	18"	20"	22"	14 - 30"
seat depth	18"	18"	20"	20"	14 - 24"
back height	27"	27"	30"	30"	24 - 36"
overall width	27"	29"	31"	33"	
overall depth	31"	31"	31"	31"	
overall height	37"	39"	44"	44"	
weight capacity	20 stone			up to 35 stone	

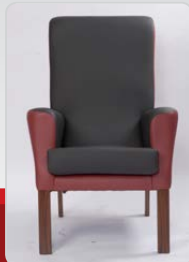

The chair is available with dark or light coloured wooden legs



Chepstow

Hospital chair

Comfortable High Back chair with removable seat cushion.

The Chepstow range of hospital chairs are available with deep comfortable removable cushions which allow for easy cleaning or the use of optional pressure care cushioning.

The chair is available in 4 sizes and bespoke, there are 2 choices of wood colour.

	Small	Medium	Large	X Large	Bespoke
seat height	16"	18"	20"	20"	14 - 25"
seat width	16"	18"	20"	22"	14 - 30"
seat depth	18"	18"	20"	20"	14 - 24"
back height	27"	27"	30"	30"	24 - 36"
overall width	27"	29"	31"	33"	
overall depth	31"	31"	31"	31"	
overall height	37"	39"	44"	44"	
weight capacity	20 stone				up to 35 stone



Drop down arm option



Housekeeping wheels optional



Height adjustable legs



Monza Infection Control | specification.

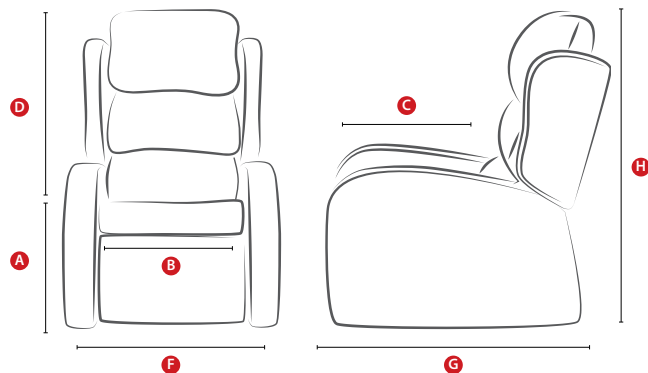

	Petite	Compact	Standard
A seat height	16"	18"	19"
B seat width	18"	18"	20"
C seat depth	18"	18"	20"
D back height	27"	27"	30"
E tilt / back angle	Single 25° / Dual 25° + extra 35°		
F overall width	27"	27"	29"
G overall depth	35"	35"	35"
H overall height	39"	41"	44"
weight capacity	20 stone		

Standard features

- Ultima vinyl Crib 5 outer with waterproof vapour permeable 4 way stretch fabric on the back cushions and seat quilt.
- Seat and back cushions have easily removed interiors allowing the cushions to be machine washed at up to 95 degrees.
- Removable cushioning attached with strong magnets.
- Chair available with single or dual tilt in space actions.

46

Monza Infection Control | features and options.



The chair has the excellent high get out position



Cushions are quickly removed pulling the magnets away from the chair. Here the top 2 waterfall cushions are removed



Chair shown with all the back cushions and seat quilt and cushions removed showing the easy clean surfaces



Cushions removed

Monza

Infection Control

The Monza Infection Control chair uses waterproof vinyls and vapour permeable fabrics but all the back cushions and seat and leg quilt are attached with magnets.

There is no Velcro used in the manufacture so all the surfaces behind the cushions are quickly accessible and easily cleaned.



primacare | always there

Brecon Contract Express

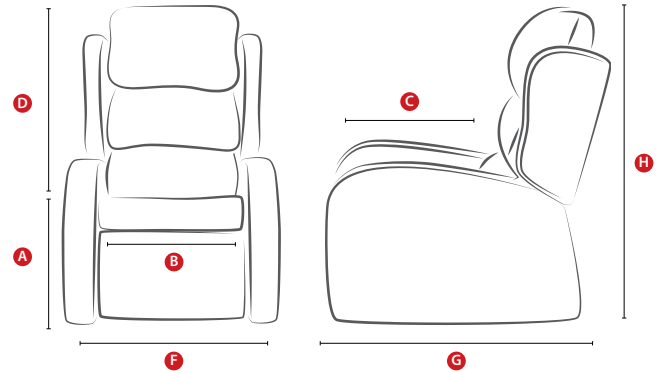

Contract Express | specification.

		Petite	Compact	Standard
A	seat height	16"	18"	19"
B	seat width	18"	18"	20"
C	seat depth	18"	18"	20"
D	back height	27"	27"	30"
E	back angle	Single 25° / Dual 25° + extra 35°		
F	overall width	27"	27"	29"
G	overall depth	35"	35"	35"
H	overall height	39"	41"	44"

Standard features

- Ultima Vinyl Crib 5 outer with waterproof vapour permeable 4 way stretch fabric to the seat, leg rest and back cushions.
- Removable seat system with visco medium risk pressure relief foam in the seat quilt
- Waterfall back cushions are removable and re-positionable.

48



The seat quilt is fully removable giving access to the seating module. This can be upgraded at a later date with other pressure management options



Fudge / Beige



Atlantic / Navy



Black / Black

Brecon & Monza

Contract Express chairs

Both chair styles come in 3 sizes, 3 colour ways and 3 action types and can be delivered very quickly.

The action types available are single tilt in space, dual motor and dual tilt in space, all with a 20 stone weight capacity.

Both chairs come as standard with fabrics to Crib 5 standard allowing their sale to, and use in, Care Homes and Hospitals.

Both chairs come with a removable seat system and 3 waterfall back cushions which can easily be adjusted to improve the comfort of the chair. Medium risk pressure relief foam is supplied as standard but the chairs can be specified with all pressure management options listed at the front of the brochure.



Monza Contract Express

Monza arm is narrower at the base allowing easier access for hoists and steadies



Updated October 2019

Your local primacare distributor is:-



Certificate no:11186 ISO9001

tel: 01685 845900 fax: 01685 844538
www.primacare.co.uk info@primacare.co.uk